

# Data Sheet



Article number: 433000055

Description: Rota-fix shaft-hub connection C 55x62

Note: Not self centering. Small radial dimensions

## Measures

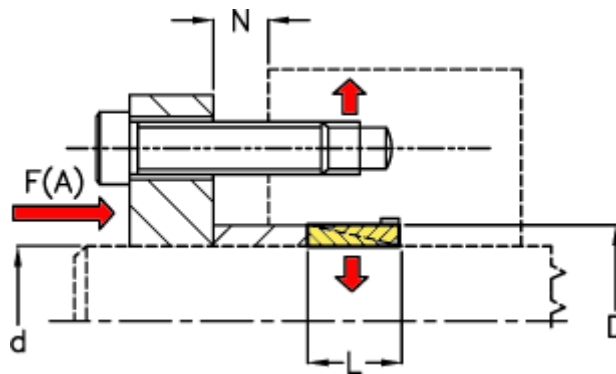

d mm = 55

D mm = 62

F(A) kN = 120

Fit tolerance = Aksel  $\varnothing$  ? 38 h6, Aksel  $\varnothing$  > 38 h8, Nav  $\varnothing$  ? 38 H7, Nav >  $\varnothing$  38 H8

F kN torque = 21.0

L = 10

N1 = 4

N2 = 5

N3

N4

P N/mm<sup>2</sup> surface press

Surface roughness

T N m torque